

FUNAI

DV220FX4 DV220FX4 A

DVD Player/VCR with Line-in Recording

Owner's Manual



© 2013 Funai Electric Co., Ltd.

PRECAUTIONS

PREPARATION

BASIC OPERATIONS

ADVANCED PLAYBACK

RECORDING

OPTIONAL SETTINGS

TROUBLESHOOTING

INFORMATION

PRECAUTIONS

Safety Instructions

The model and serial numbers of this unit may be found on the cabinet.
You should record and retain those numbers for future reference.

Model No.: _____

Serial No.: _____

WARNING: TO REDUCE THE RISK OF FIRE OR ELECTRIC SHOCK, DO NOT EXPOSE THIS APPARATUS TO RAIN OR MOISTURE. APPARATUS SHALL NOT BE EXPOSED TO DRIPPING OR SPLASHING AND NO OBJECTS FILLED WITH LIQUIDS, SUCH AS VASES, SHALL BE PLACED ON THE APPARATUS.



CAUTION
RISK OF ELECTRIC SHOCK
DO NOT OPEN



The lightning flash with arrowhead symbol, within an equilateral triangle, is intended to alert the user to the presence of uninsulated "dangerous voltage" within the product's enclosure that may be of sufficient magnitude to constitute a risk of electric shock to persons.

CAUTION: TO REDUCE THE RISK OF ELECTRIC SHOCK, DO NOT REMOVE COVER (OR BACK). NO USER SERVICEABLE PARTS INSIDE. REFER SERVICING TO QUALIFIED SERVICE PERSONNEL.



The exclamation point within an equilateral triangle is intended to alert the user to the presence of important operating and maintenance (servicing) instructions in the literature accompanying the appliance.

The important note and rating are located on the rear or bottom of the cabinet.

IMPORTANT SAFETY INSTRUCTIONS

1. Read these instructions.
2. Keep these instructions.
3. Heed all warnings.
4. Follow all instructions.
5. Do not use this apparatus near water.
6. Clean only with dry cloth.
7. Do not block any ventilation openings. Install in accordance with the manufacturer's instructions.
8. Do not install near any heat sources such as radiators, heat registers, stoves, or other apparatus (including amplifiers) that produce heat.
9. Do not defeat the safety purpose of the polarized or grounding-type plug. A polarized plug has two blades with one wider than the other. A grounding type plug has two blades and a third grounding prong. The wide blade or the third prong are provided for your safety. If the provided plug does not fit into your outlet, consult an electrician for replacement of the obsolete outlet.
10. Protect the power cord from being walked on or pinched particularly at plugs, convenience receptacles, and the point where they exit from the apparatus.
11. Only use attachments/accessories specified by the manufacturer.
12. Use only with the cart, stand, tripod, bracket, or table specified by the manufacturer, or sold with the apparatus. When a cart is used, use caution when moving the cart/apparatus combination to avoid injury from tip-over.
13. Unplug this apparatus during lightning storms or when unused for long periods of time.
14. Refer all servicing to qualified service personnel. Servicing is required when the apparatus has been damaged in any way, such as power-supply cord or plug is damaged, liquid has been spilled or objects have fallen into the apparatus, the apparatus has been exposed to rain or moisture, does not operate normally, or has been dropped.



FCC WARNING

This equipment may generate or use radio frequency energy. Changes or modifications to this equipment may cause harmful interference unless the modifications are expressly approved in the manual. The user could lose the authority to operate this equipment if an unauthorized change or modification is made.

RADIO-TV INTERFERENCE

This equipment has been tested and found to comply with the limits for a Class B digital device, pursuant to Part 15 of the FCC Rules. These limits are designed to provide reasonable protection against harmful interference in a residential installation. This equipment generates, uses, and can radiate radio frequency energy and, if not installed and used in accordance with the instructions, may cause harmful interference to radio communications. However, there is no guarantee that interference will not occur in a particular installation. If this equipment does cause harmful interference to radio or television reception, which can be determined by turning the equipment off and on, the user is encouraged to try to correct the interference by one or more of the following measures:

- 1) Reorient or relocate the receiving antenna.
- 2) Increase the separation between the equipment and receiver.
- 3) Connect the equipment into an outlet on a circuit different from that to which the receiver is connected.
- 4) Consult the dealer or an experienced radio/TV technician for help.

Disconnect the mains plug to shut off when find trouble or not in use. The mains plug shall remain readily operable.

PRECAUTIONS

CAUTION: Danger of explosion if battery is incorrectly replaced. Replace only with the same or equivalent type.
WARNING: Batteries (Battery pack or battery installed) shall not be exposed to excessive heat such as sunshine, fire, or the like.

LASER SAFETY

This apparatus is classified as a CLASS 1 LASER PRODUCT.

This apparatus employs a laser. Only a qualified service person should remove the cover or attempt to service this apparatus, due to possible eye injury.

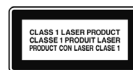

CAUTION: Use of controls or adjustments or performance of procedures other than those specified herein may result in hazardous radiation exposure.

IMPORTANT COPYRIGHT INFORMATION

Unauthorized copying, broadcasting, public performance and lending of discs are prohibited. This item incorporates copy protection technology that is protected by U.S. patents and other intellectual property rights of Rovi Corporation. Reverse engineering and disassembly are prohibited.

Do not place the unit on the furniture that is capable of being tilted by a child and an adult leaning, pulling, standing or climbing on it. A falling unit can cause serious injury or even death.

Never use a gas duster on this unit.
The gas trapped inside of this unit may cause ignition and explosion.

To Avoid the Hazards of Electrical Shock and Fire

- Do not handle the power cord with wet hands.
- Do not pull on the power cord when disconnecting it from an AC outlet. Grasp it by the plug.
- Do not put your fingers or objects into the unit.

Location and Handling

- Do not install the unit in direct sunlight, near strong magnetic fields, or in a place subject to dust or strong vibration.
- Avoid a place with drastic temperature changes.
- Install the unit in a horizontal and stable position. Do not place anything directly on top or bottom of the unit. Depending on your external devices, noise or disturbance of the picture and/or sound may be generated if the unit is placed too close to them. In this case, please ensure enough space between the external devices and the unit.
- Depending on the environment, the temperature of this unit may increase slightly. This is not a malfunction.
- Be sure to remove the disc and unplug the AC power cord from the outlet before carrying the unit.

Dew Condensation Warning

- Dew condensation may form inside the unit in the following conditions. If so, do not use this unit at least for a few hours until its inside gets dry.
 - The unit is moved from a cold place to a warm place.
 - Under conditions of high humidity.
 - After heating a cold room.

Note about Recycling



- This unit's packaging materials are recyclable and can be reused. Please dispose of any materials in accordance with your local recycling regulations.
- Batteries should never be thrown away or incinerated but disposed of in accordance with your local regulations concerning chemical wastes.
- For product recycling information, please visit - www.funaiamerica.com



Notice for Progressive Scan Output

- Consumers should note that not all high definition television sets are fully compatible with this product and may cause artifacts to be displayed in the picture. In case of picture problems with 525(480) progressive scan output, it is recommended that the user switch the connection to the 'standard definition' output. If there are questions regarding your TV set compatibility with this 525p(480p) DVD player, please contact our customer service center.

Trademark Information

-  **DOLBY DIGITAL** Manufactured under license from Dolby Laboratories. Dolby and the double-D symbol are trademarks of Dolby Laboratories.
-  is a trademark of DVD Format/Logo Licensing Corporation.

PREPARATION

Contents

PRECAUTIONS

Safety Instructions 2

PREPARATION

Supplied Accessories 4

About Cassette Tapes and Discs 5

Playable Media 5

Unplayable Disc 5

Region Code 5

Color System 5

Function Overview 6

Remote Control 6

Front Panel 8

Rear Panel 9

Installing the Batteries for the Remote Control 9

Connections 10

Connection to a TV 10

Connection to an Audio System 12

Initial Setups 13

Turning on Unit for the First Time 13

Clock Setting 13

BASIC OPERATIONS

For VCR Playback 14

For Disc Playback 14

Hint for Disc Playback 15

Fast Forward / Fast Reverse Playback 15

Still Mode / Step-by-step Playback 15

Slow Forward Playback 15

To Skip the Titles, Chapters or Tracks 15

To Reset the Cassette Tape Counter (Counter Reset) 15

To Rewind the Cassette Tape automatically (Auto Rewind) 15

ADVANCED PLAYBACK

Disc Menu 16

Calling Up a Menu Screen During Playback 16

Resume Playback 16

Zoom 16

Camera Angles 16

Stereo Sound Mode 16

Title, Chapter or Track Search 16

Index Search 17

Time Search 17

Repeat Playback 17

Repeat A-B Playback 17

Auto Repeat Playback 17

Programmed Playback 18

Random Playback 18

Settings 18

Black Level Setting 18

Subtitle Language and Audio Language 19

On-Screen Display 19

RECORDING

Recording & OTR (One-touch Timer Recording) 20

Timer Recording 21

Note for Timer Recording & OTR 21

Satellite Link 22

Dubbing a Cassette Tape 22

OPTIONAL SETTINGS

Changing the DVD Settings (in the setup menu) ... 23

PARENTAL Setting 24

INITIALIZE 25

TROUBLESHOOTING

Troubleshooting Guide 26

INFORMATION

Maintenance 27

Specifications 27

LIMITED WARRANTY back cover

Supplied Accessories

Remote Control
(NB681UD / NB681UH)



RCA audio/video cables

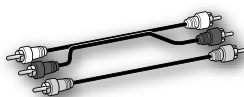

AA (1.5V DC) battery x 2

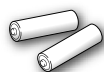

Quick Start Guide



Owner's Manual

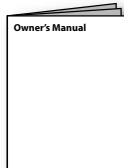

FUNAI is a registered trademark of Funai Electric Co., Ltd. and may not be used in any way without the express written consent of Funai.

© 2013 Funai Electric Co., Ltd.











All rights reserved. No part of this manual may be reproduced, copied, transmitted, disseminated, transcribed, downloaded or stored in any storage medium, in any form or for any purpose without the express prior written consent of Funai. Furthermore, any unauthorized commercial distribution of this manual or any revision hereto is strictly prohibited.

Information in this document is subject to change without notice. Funai reserves the right to change the content herein without the obligation to notify any person or organization of such changes.

PREPARATION

About Cassette Tapes and Discs

Playable Media

Media Type	DVD-VIDEO	DVD-RW	DVD-R	CD-DA	CD-RW	CD-R	Cassette Tape
Logo							
Symbols used in this manual							
Recorded Signal	digital video (MPEG2)			digital audio			analog video

Unplayable Disc

Caution: Never play the following discs.

- DVD-RAM
- DVD with region codes other than 1 or ALL
- DVD-audio
- DTS-CD
- CD-i
- DVD-ROM for personal computers
- photo CD
- CD-ROM for personal computers
- video CD
- the discs with labels, scratches, stains, blemishes, etc.
- HD DVD
- Blu-ray disc

Caution: The sound may not be heard on the following disc.

- super audio CD

Note: • Only the sound recorded on the normal CD layer can be delivered. The sound recorded on the high density super audio CD layer cannot be delivered.

Any other discs without compatibility indications

- Note:**
- Unfinalized discs cannot be played back.
 - For DVD-RW/R, discs recorded in the VR (video recording) format cannot be played back. Only the finalized video format discs can be played back.
 - Some discs cannot be played back because of incompatible recording conditions, characteristics of the recorder or special properties of discs.
 - You can play back discs which bear the marks listed in "Playable Media". If you use nonstandardized discs, this unit may not play them back. Even if they are played back, the sound or video quality will be compromised.
 - If the recorded portion of the disc is too small (less than 2-3/16 inches (55 mm) across), it may not play back properly.

Region Code

This unit has been designed to play back DVD with region 1. DVD must be labeled for ALL regions or for region 1 in order to play back on the unit. You cannot play back DVD that are labeled for other regions. Look for the symbols on your DVD. If these region symbols do not appear on your DVD, you cannot play back the DVD in this unit.



The number inside the globe refers to region of the world. A DVD labeled for a specific region can only be played back on the unit with the same region code.

Color System

DVD is recorded in different color systems throughout the world. The most common color system is NTSC (which is used primarily in the United States and Canada).

This unit uses NTSC, so DVD you play back must be recorded in the NTSC system. You cannot play back DVD recorded in PAL color systems.

PREPARATION

Function Overview

Remote Control

Button names described in this Owner's Manual

The instructions in this manual rest primarily on the premise that you will operate using the remote control (Please be informed that some operations can only be made on the front panel of the unit).

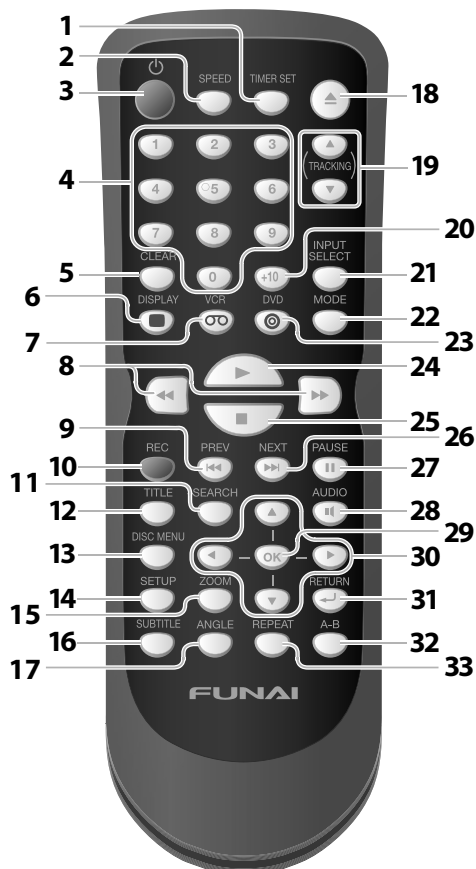

1. **TIMER SET (VCR)** ↪ p.21

- Press to put the VCR into standby mode for a timer recording.

Pulse para colocar el VCR en modo espera para una grabación con temporizador.

2. **SPEED (VCR)** ↪ p.20

- Press to select the recording speed.

Pulse para seleccionar la velocidad de grabación.

3. **⏻** ↪ p.13

- Press to turn on the unit, or to turn the unit into the standby mode. (To completely turn off the unit, you must unplug the AC power cord.)

Pulse el botón para encender la unidad, o para pasar la unidad al modo de espera. (Para apagar completamente la unidad, debe desconectar el cable de alimentación de CA.)

4. **Number buttons (DVD)** ↪ p.16

- Press to select chapter / title (DVD), track (CD) directly.

Pulse para seleccionar un capítulo o título (DVD) o pista (CD) directamente.

5. **CLEAR** ↪ p.13

DVD mode:

- Press to clear numbers entered incorrectly. (DVD, CD)
Pulse para borrar los números ingresados incorrectamente. (DVD, CD)
- Press to cancel the point for A-B repeat. (DVD, CD)
Pulse para cancelar el punto para repetición de A-B. (DVD, CD)
- Press to clear all the tracks entered for programmed playback. (DVD, CD)
Pulse para borrar todas las pistas ingresadas para la reproducción programada. (DVD, CD)

VCR mode:

- Press to exit the VCR menu.
Pulse para salir del menú de VCR.
- Press to reset the cassette tape counter.
Pulse para restaurar el contador del casete.

6. **DISPLAY** ↪ p.19

DVD mode:

- Press to display the current disc mode.
Pulse para visualizar el modo de disco actual.

VCR mode:

- Press to display the current time, cassette tape counter, and L1 / L2.
Pulse para visualizar la hora actual, el contador del casete y L1 o L2.

7. **VCR** (VCR) ↪ p.13

- Press to activate VCR mode.
Pulse para activar el modo de VCR.

8. **◀▶** ↪ p.15

DVD mode:

- Press to search forward / backward through a disc.
Pulse para buscar hacia adelante o hacia atrás en el disco.
- Press [▶▶] to begin slow forward playback in the pause mode. (DVD)
Pulse [▶▶] para iniciar la reproducción lenta hacia adelante en el modo pausa. (DVD)

VCR mode:

- Press to forward / backward a cassette tape.
Pulse para adelantar o retroceder un casete.
- Press [▶▶] to begin slow forward playback in the pause mode.
Pulse [▶▶] para iniciar la reproducción lenta hacia adelante en el modo pausa.

9. **◀◀ (DVD)** ↪ p.15

- Press to go back to the previous chapters / titles. (DVD)
Pulse para volver a los capítulos o títulos anteriores. (DVD)
- Press to go back to the previous tracks (CD).
Pulse para volver a las pistas (CD) anteriores.

10. **REC (VCR)** ↪ p.20

- Press to start recording or press repeatedly to activate the One-touch Timer Recording.
Pulse para comenzar a grabar o pulse reiteradamente para activar la grabación rápida con temporizador.

11. **SEARCH** ↪ p.16

DVD mode:

- Press to search chapter / title (DVD).
Pulse para buscar un capítulo o título (DVD).
- Press to search track (CD).
Pulse para buscar una pista (CD).
- Press to search time (DVD, CD).
Pulse para buscar la hora (DVD, CD).

VCR mode:

- Press to call up the index or time search menu.
Pulse para visualizar el menú de búsqueda de hora o el índice.

Continued on Next Page.

PREPARATION

12. TITLE (DVD) ↵ p.16

- Press to call up the top menu on disc. (DVD)
Pulse para visualizar el menú principal del disco. (DVD)

13. DISC MENU (DVD) ↵ p.16

- Press to call up the disc menu on a disc. (DVD)
Pulse para visualizar el menú del disco en un disco. (DVD)

14. SETUP ↵ p.23

DVD mode:

- Press to call up the DVD menu.
Pulse para visualizar el menú de DVD.

VCR mode:

- Press to call up the VCR menu.
Pulse para visualizar el menú de VCR.

15. ZOOM (DVD) ↵ p.16

- Press repeatedly to magnify part of a picture. (2x, 3x, 4x or 1/2x) (DVD)
Pulse para amplificar parte de una imagen. (2x, 3x, 4x ó 1/2x) (DVD)

16. SUBTITLE (DVD) ↵ p.19

- Press to select subtitles on a disc. (DVD)
Pulse para seleccionar subtítulos en un disco. (DVD)

17. ANGLE (DVD) ↵ p.16

- Press to select camera angles on a disc. (DVD)
Pulse para seleccionar ángulos de la cámara en un disco. (DVD)

18. ▲ ↵ p.14

DVD mode:

- Press to open or close the disc tray.
Pulse para abrir o cerrar la bandeja del disco.

VCR mode:

- Press to remove the videotape from the cassette compartment.
Presiónelo para retirar la cinta de video del compartimiento del casete.

19. TRACKING ▲/▼ (VCR) ↵ p.15

- Press either one of the buttons to stabilize the picture manually or the picture begins to vibrate vertically during the still mode.
Pulse cualquiera de los botones para estabilizar la imagen de forma manual si ésta comienza a vibrar de forma vertical durante el modo pausa.

20. +10 (DVD)

- Press to change title / chapter / track number by 10 at a time.
Pulse para cambiar un título, capítulo, carpeta o número de pista de 10 por vez.

21. INPUT SELECT (VCR) ↵ p.20

- Press to select input "L1" / "L2".
Pulse para seleccionar entrada "L1" o "L2".

22. MODE (DVD) ↵ p.18

- Press to set black level ON / OFF. (DVD)
Pulse para apagar o encender nivel de negro. (DVD)
- Press to arrange the playing order or to perform random playback. (DVD, CD)
Pulse para organizar el orden de reproducción o para ejecutar la reproducción aleatoria. (DVD, CD)

23. DVD © (DVD) ↵ p.14

- Press to activate DVD mode.
Pulse para activar el modo de DVD.

24. ▶ ↵ p.14

- Press to begin the playback of a disc / a cassette tape.
Pulse para comenzar la reproducción de un disco o casete.

25. ■ ↵ p.14

DVD mode:

- Press to stop disc playback.
Pulse para detener la reproducción del disco.

VCR mode:

- Press to stop the playback / recording of a cassette tape.
Pulse para detener la reproducción o grabación de un casete.

26. ►► (DVD) ↵ p.15

- Press to skip chapters / titles. (DVD)
Pulse para saltar capítulos o títulos. (DVD)
- Press to skip tracks (CD).
Pulse para saltar pistas (CD).

27. II ↵ p.15

DVD mode:

- Press to pause disc playback.
Pulse para pausar la reproducción del disco.
- Press to advance the playback one frame at a time. (DVD)
Pulse para avanzar la reproducción un cuadro por vez. (DVD).

VCR mode:

- Press to pause the playback / recording of a cassette tape.
Pulse para pausar la reproducción o grabación de un casete.
- Press to advance the playback one frame at a time.
Pulse para avanzar la reproducción un cuadro por vez.

28. AUDIO 🗨️ (DVD) ↵ p.19

- Press to select audio languages on a disc. (DVD)
Pulse para seleccionar idiomas de audio en un disco. (DVD)
- Press to select "STEREO" / "L-ch" / "R-ch". (CD)
Pulse para seleccionar "STEREO", "L-ch" o "R-ch". (CD)

29. OK (DVD) ↵ p.16

- Press to confirm the items.
Pulse para confirmar los ítems.

30. ▲ / ▼ / ◀ / ▶ ↵ p.16

DVD mode:

- Press to select items / settings.
Pulse para seleccionar ítems o ajustes.

VCR mode:

▲ / ▼ :

- Press to select an item on the VCR menu.
Pulse para seleccionar un ítem en el menú de la VCR.

◀ :

- Press to go back one step during clock and timer programming.
Pulse para retroceder un paso durante la programación del reloj el temporizador.

▶ :

- Press to proceed to the next VCR menu item / step.
Pulse para ir al siguiente menú de VCR.

31. RETURN ↶ (DVD) ↵ p.18

- Press to return to the previous operation in this menu.
Pulse para volver a la operación anterior en el menú.

32. A-B (DVD) ↵ p.17

- Press to repeat between your chosen point of A and B. (DVD, CD)
Pulse para repetir entre los puntos de A y B que seleccionó. (DVD, CD)

33. REPEAT ↵ p.17

DVD mode:

- Press to play back a chapter / title repeatedly. (DVD)
Pulse para reproducir un capítulo o título reiteradamente. (DVD)
- Press to play back a track / disc repeatedly. (CD)
Pulse para reproducir una pista o disco reiteradamente. (CD)

VCR mode:

- Press to select the repeat mode ON / OFF.
Pulse para encender o apagar el modo de repetición.

Note: • This unit will automatically turn on the screen saver after 5 minutes of inactivity and enter standby mode after 25 minutes of inactivity.

PREPARATION

Front Panel

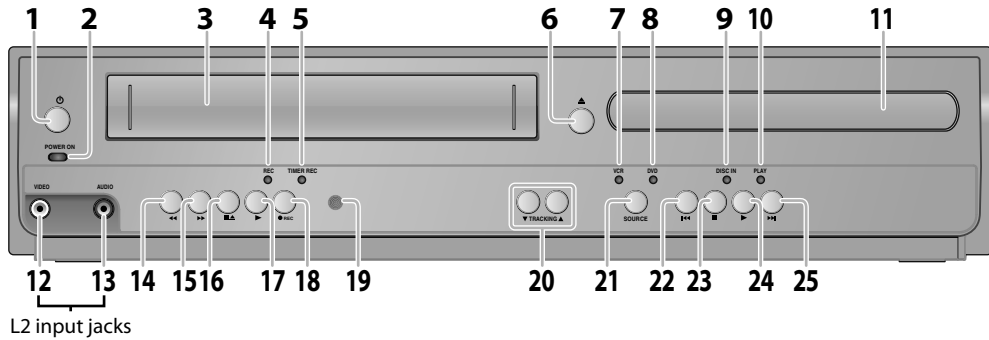

L2 input jacks

1. ↪ p.14
 - Press to turn On the unit, or to turn the unit into the Standby mode. (To completely turn Off the unit, you must unplug the AC power cord.)
2. **POWER ON indicator**
 - Lights up when the unit is turned On.
3. **Cassette Compartment (VCR)** ↪ p.14
 - Insert a cassette tape here.
4. **REC indicator (VCR)**
 - Lights up during a Recording, OTR (One-touch Timer Recording) or Timer Recording.
 - Blinks when a Recording is paused.
5. **TIMER REC indicator (VCR)** ↪ p.21
 - Lights up when a Timer Recording or OTR (One-touch Timer Recording) has been set.
 - Blinks when a Timer Recording or OTR (One-touch Timer Recording) has been finished or if the unit could not complete the Recording due to some error.
6. (DVD) ↪ p.14
 - Press to Open / Close the disc tray.
7. **VCR output indicator (VCR)**
 - Lights up when the unit is in the VCR mode.
8. **DVD output indicator (DVD)**
 - Lights up when the unit is in the DVD mode.
9. **DISC IN indicator (DVD)**
 - Lights up when the disc is in the disc tray.
10. **PLAY indicator (DVD)**
 - Lights up when the inserted disc is being played back.
 - Blinks when an unplayable disc is inserted.
11. **Disc tray (DVD)** ↪ p.14
 - Place a disc when it is open.
12. **VIDEO IN jack (VCR)** ↪ p.22
 - Connect an RCA video cable from the video output jack of your camcorder and other such devices here.
13. **AUDIO IN jack (VCR)** ↪ p.22
 - Connect an RCA monaural audio cable from the audio output jack of your camcorder and other such devices here.
14. (VCR) ↪ p.15
 - Press to rewind the cassette tape or to view the picture rapidly in reverse during playback (rewind search).
15. (VCR) ↪ p.15
 - Press to rapidly advance the cassette tape or view the picture rapidly in forward during playback (forward search).
16. (VCR) ↪ p.14
 - Press to Stop the Playback / Recording of a cassette tape.
17. (VCR) ↪ p.14
 - Press to Start the Playback of a cassette tape.
18. (VCR) ↪ p.20
 - Press once to Start a Recording.
 - Press repeatedly to activate an OTR (One-touch Timer Recording).
19. **Infrared Sensor Window** ↪ p.9
 - Receive signals from the Remote Control so that you can control the unit from a distance.
20. **TRACKING (VCR)** ↪ p.15
 - Press either one of the buttons to stabilize the picture if the picture begins to vibrate vertically during the cassette tape playback.
21. **SOURCE**
 - Press to switch to either DVD / VCR mode.
22. (DVD) ↪ p.15
 - Press to go back to the Previous Chapters / Titles / Tracks during Playback.
 - Press and hold it to begin Fast Reverse Search.
23. (DVD) ↪ p.14
 - Press once to Stop disc playback temporarily.
24. (DVD) ↪ p.14
 - Press to Start / Resume Playback.
25. (DVD) ↪ p.15
 - Press to Skip Chapters / Titles / Tracks during Playback.
 - Press and hold it to begin Fast Forward Search.

Note:

- You can turn On the unit by pressing the buttons 6 or 24 (circled ones) or by inserting a cassette tape.
- If you turn Off this unit, [] on the Remote Control is not available. Be sure to use [] or [] on the unit.

PREPARATION

Rear Panel

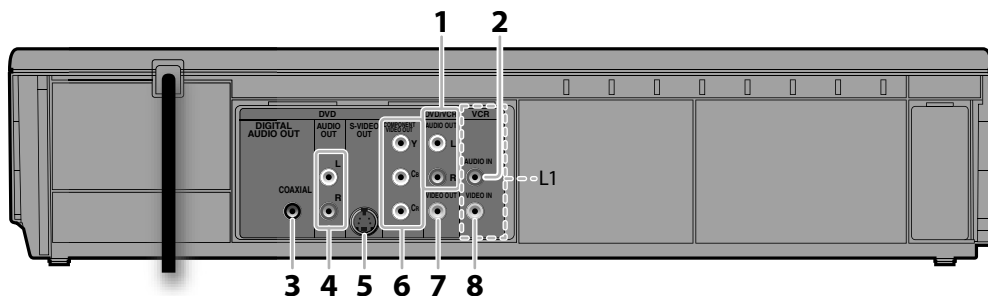

1. DVD/VCR AUDIO OUT jack ↪ p.10

- Connect an RCA audio cable from here to the audio input jack on your television or audio device. Standard connection for DVD/VCR use.

2. VCR AUDIO IN jack ↪ p.22

- Connect an RCA audio cable from the audio output jack on your camcorder, VCR, etc. to here.

3. DIGITAL AUDIO OUT COAXIAL* jack ↪ p.12

- Connect a digital audio coaxial cable from here to the digital audio coaxial in jack on a decoder or audio receiver.

4. DVD AUDIO OUT* (analog) jack ↪ p.11

- Connect an RCA audio cable from here to the audio input jack on your television or audio device.

5. S-VIDEO OUT* jack ↪ p.11

- Connect an S-video cable from here to the S-video input jack on your television.

6. COMPONENT VIDEO OUT* jacks ↪ p.11

- Connect component video cables from here to the component video input jacks on your television.

7. DVD/VCR VIDEO OUT jack ↪ p.10

- Connect an RCA video cable from here to the VIDEO input jack of your television or audio device. Standard connection for DVD/VCR use.

8. VCR VIDEO IN jack ↪ p.22

- Connect an RCA video cable from here to the video output jack on your camcorder, VCR, etc.

* For enhanced DVD viewing. DVD/VCR video and audio connection required to view cassette tapes.

Note: • RCA audio and video cables are included for both VCR and DVD viewing. You can enhance your DVD picture and sound quality with an S-video cable, component video cables, or a digital audio coaxial cable. **Please purchase the necessary cables at your local store.** (Refer to pages 11-12.)

Installing the Batteries in the Remote Control

Install the 2 AA (1.5 V) batteries matching the polarity indicated inside battery compartment of the remote control.

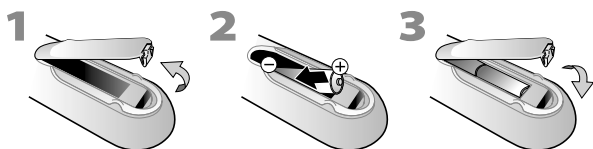

Keep the following in mind when using the remote control:

- Make sure that there are no obstacles between the remote control and the infrared sensor window on the unit.
- The maximum operable ranges of the unit are:
 - **Line of sight:** approx. 23 feet (7m)
 - **Either side of center:**
 - approx. 16 feet (5m) within 30°
 - **Above:** approx. 16 feet (5m) within 15°
 - **Below:** approx. 10 feet (3m) within 30°

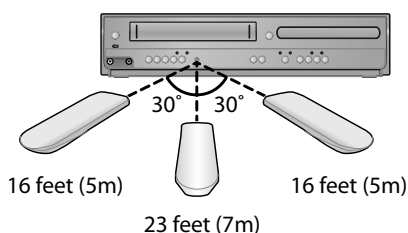

Caution: Never throw batteries into a fire.

Note: • Do not mix different types of batteries together (e.g., Alkaline and Carbon-Zinc) or old batteries with fresh ones. Although they may look similar, different batteries may have different voltages.

- If the remote control is not to be used for a long period of time, remove the batteries to prevent damage or injury from possible battery leakage.
- Do not try to recharge batteries; they can overheat and rupture.
- Batteries should always be disposed of with the environment in mind. Always dispose of batteries in accordance with applicable laws and regulations.

PREPARATION

Connections

Connection to a TV

If Your TV Has an Antenna In Jack Only

Before connecting, make sure the Power on the devices are turned Off.

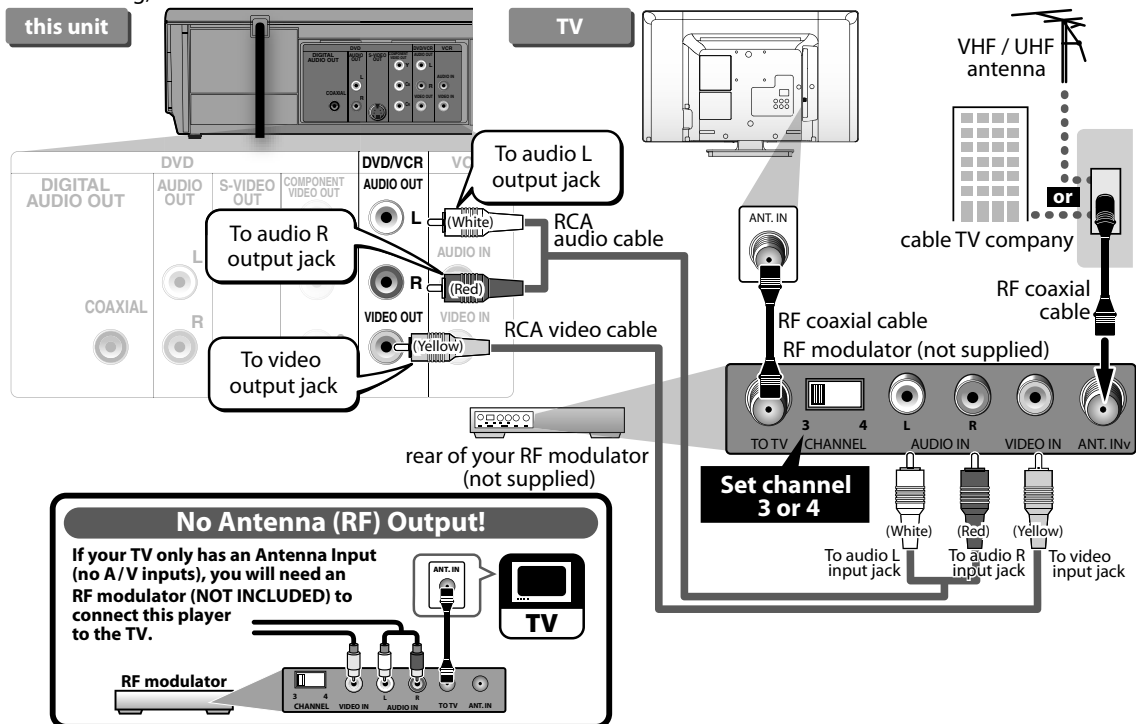

After making the connection illustrated above;

- 1) Set your RF modulator's channel 3/4 switch to either 3 or 4, whichever the TV channel is least used in your area.
- 2) Turn on your TV and choose the same channel as you set the RF modulator's channel 3/4 switch to.

Note: • The quality of picture may become poor if this unit is connected to an RF modulator.

VCR and Basic DVD Connection

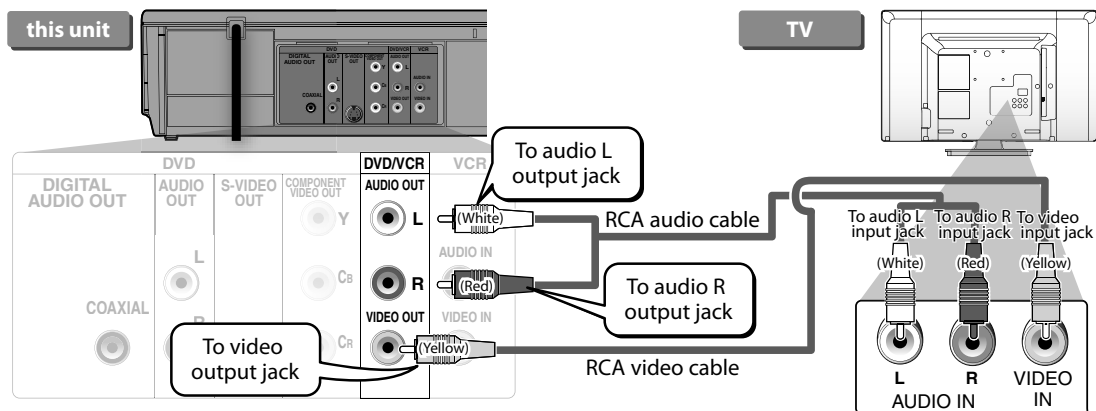

Note: • Connect this unit directly to your TV. If an RCA audio/video cables are connected to a VCR, pictures may be distorted due to the copy protection system.

Supplied cables used in this connection are as follows:

- RCA audio cable (L/R) x 1
- RCA video cable x 1

Please purchase the rest of the necessary cables at your local store.

PREPARATION

After connecting to your TV:

You will need to switch to video input on your TV. This is usually marked TV/VIDEO, INPUT or AUX. Please refer to your TV's owner's manual for details.

Input modes for common TV brands:

Listed below are inputs for common brand name TV's.

Admiral: AUX	KENWOOD: AUX	Samsung: TV/VIDEO
Curtis Mathis: LINE1, LINE2, 00, 90, 91, 92, 93	LXI-Series: 00	SANYO: VIDEO
GE: INPUT, TV/VCR, 00, 90, 91, 92, 93	Funai: AUX CHANNEL	SHARP: 00
HITACHI: INPUT, AUX	Panasonic: TV/VIDEO	SONY: VIDEO1, VIDEO2, VIDEO3
JVC: VIDEO, VIDEO1, VIDEO2, VIDEO3	RCA: INPUT, TV/VCR, 00, 90, 91, 92, 93	TOSHIBA: TV/GAME
		Zenith: 00

Available on DVD Only

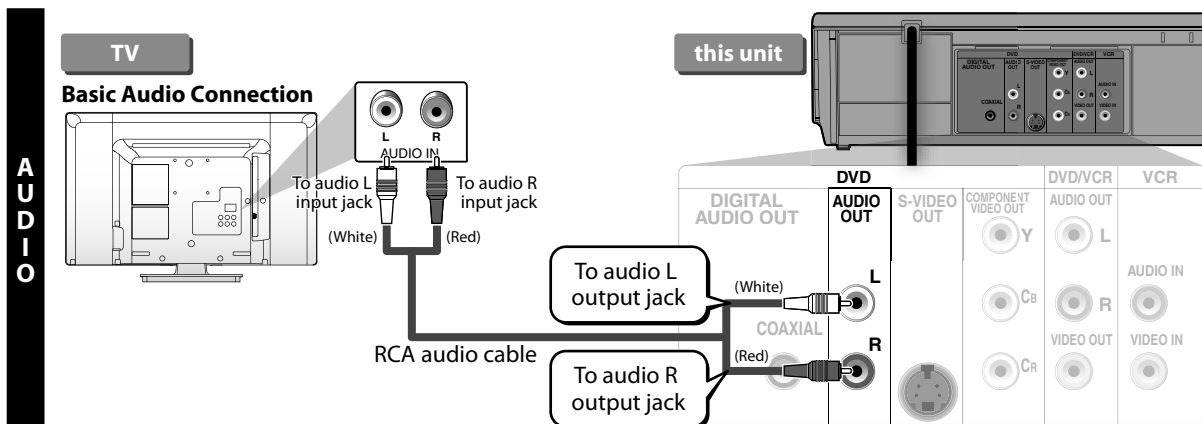

and

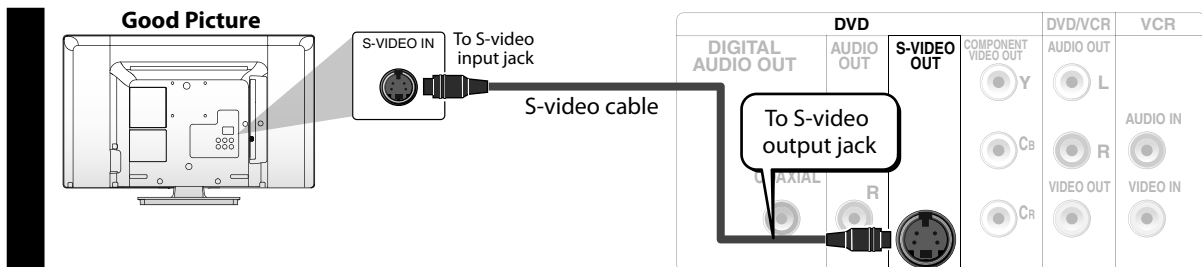

or

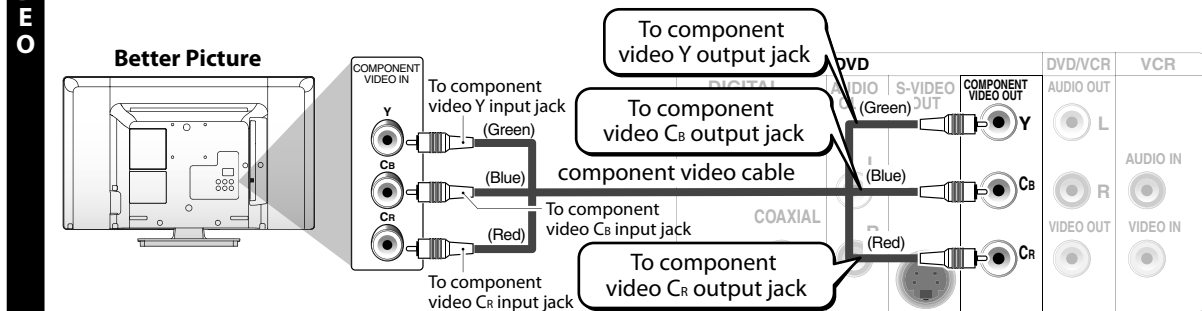

Supplied cables used in this connection are as follows:

- RCA audio cable (L/R) x 1
- RCA video cable x 1

Please purchase the rest of the necessary cables at your local store.

PREPARATION

Connection to an Audio System

Playing Analog Audio

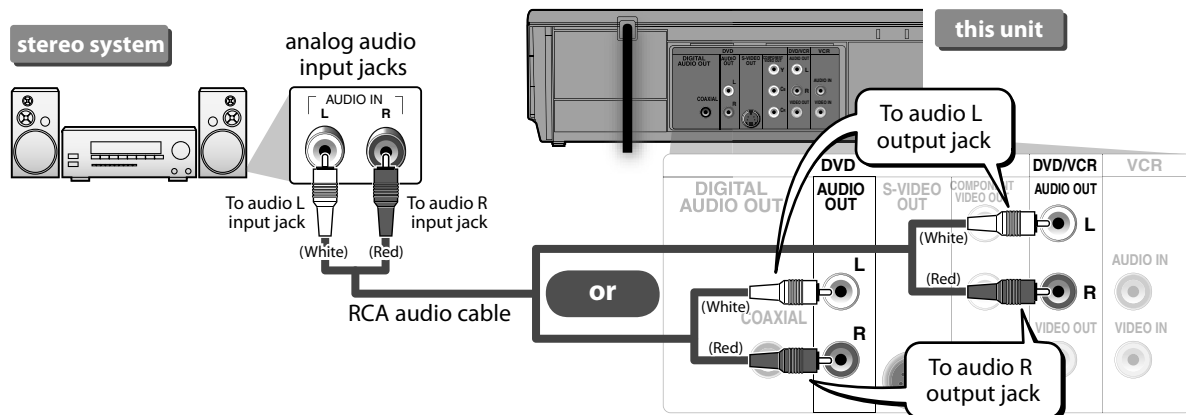

Supplied cables used in this connection are as follows:

- RCA audio cable (L/R) x 1

Please purchase the rest of the necessary cables at your local store.

Playing Digital Audio

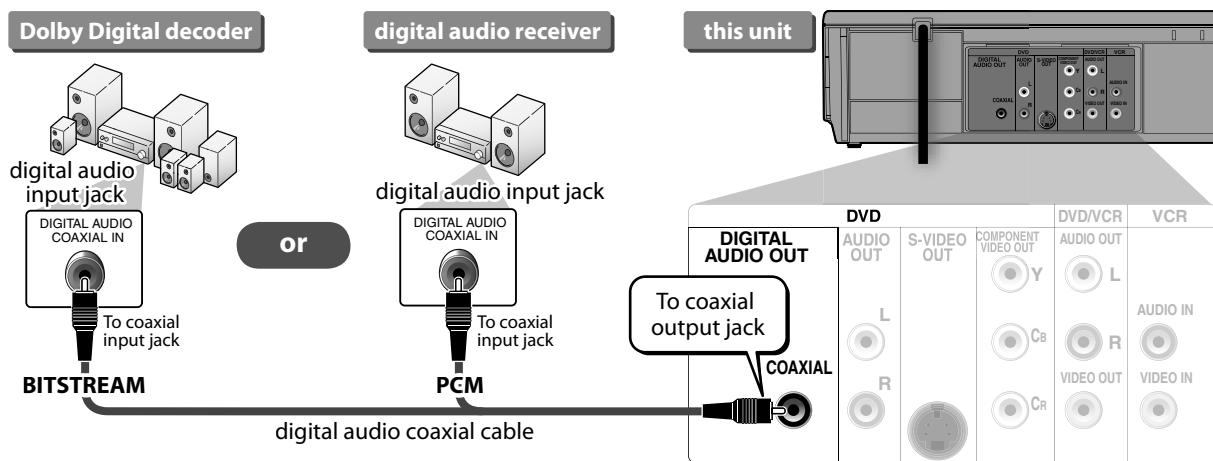

* You must select "BITSTREAM" or "PCM" in "DOLBY DIGITAL" setting. (Refer to page 23.)

Audio recording format of the disc	"Dolby Digital" setting on this unit	Actual output	
DVD-video	Dolby Digital	PCM	2channel PCM
		BITSTREAM	Dolby Digital
	LPCM	PCM	2channel PCM
		BITSTREAM	

Note:

- The audio source on a disc in a Dolby Digital multi channel surround format cannot be recorded as digital sound by an MD or DAT deck.
- Playing back a DVD using incorrect settings may generate noise distortion and may also damage the speakers.

Initial Setups



Turning On Unit for the First Time

Press  first.

Please note: most instructions in this manual refer to remote control use.

1 Be sure your TV's input is set to VIDEO. (Name may vary with TV manufacturer. See your TV manual for details.)

2 Press .
• "LANGUAGE SELECT" menu appears.

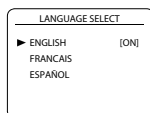

3 Use  /  to select your on-screen language. Then press  to continue.





4 When "CLOCK SET" menu appears, go to step 2 in "Clock Setting" on this page.

To Change the Selected On-screen Language

1 Press  until the main menu appears.

2 Use  /  to select "LANGUAGE SELECT". Then press  to go to next step.

3 Use  /  to select "ENGLISH", "FRANCAIS" or "ESPAÑOL". Then press .

Note: • If you accidentally select Spanish or French and need English:
Press **[SETUP]** and choose "SELEC. IDIOMA" or "SELECTION LANGUE". Press **[▶]** and select "ENGLISH". Finally, press **[CLEAR]**.



Clock Setting

Press  first.

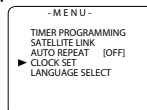

1 Press  and use  /  to select "CLOCK SET". Then press  to go to next step.



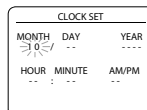

• If the clock is not set yet, the "CLOCK SET" menu appears when you press . In this case, go to step 2.

2 Use  /  to select the contents to suit your preference. Then press  to go to the next item.

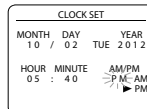

3 Use  /  to select "AM" or "PM".



4 Press  to exit the "CLOCK SET" menu.

Note: • To go back, press **[◀]** during steps 2 to 3.
• Clock setting will be lost after a power failure or this unit has been unplugged for more than 30 seconds.

BASIC OPERATIONS

BASIC PLAYBACK

Before: Turn on the TV.

For VCR Playback

- 1** Insert a cassette tape so that the unit will be turned on automatically.
Inserte un casete para que la unidad se encienda automáticamente.

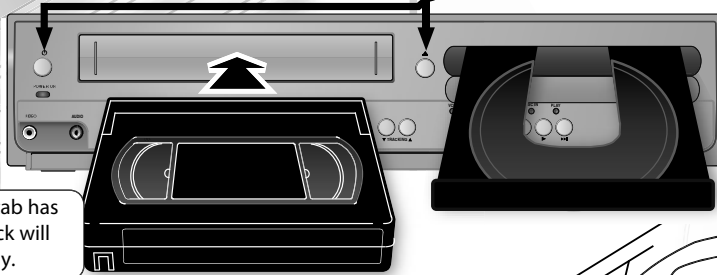

• If the protection tab has removed, playback will start automatically.

- 2** Press to switch to the VCR mode.
Para cambiar al modo de VCR, pulse .

REMEMBER

- You need to press first every time you operate any of VCR features.
- When using DVD AUDIO OUT jack, DIGITAL AUDIO OUT COAXIAL jack, COMPONENT VIDEO OUT jack and S-VIDEO OUT jack, no VCR audio / video will be output.

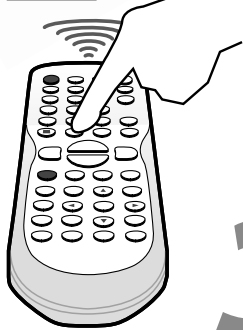

- 3** Press to start playback.
Pulse para comenzar la reproducción.



- 4** Press to stop the playback.
Pulse para detener la reproducción.

For advanced playback, refer to the following pages.

- Time Search p.17
- Index Search p.17
- Auto Repeat p.17

Note:

- To prevent damage to the cassette tape, still or slow mode will automatically stop after 5 minutes.
- To return to playback from the picture search, still or slow mode, press .

For Disc Playback

- 1** Press to turn on the unit. Then press .
- Para encender la unidad, pulse . Luego pulse .*

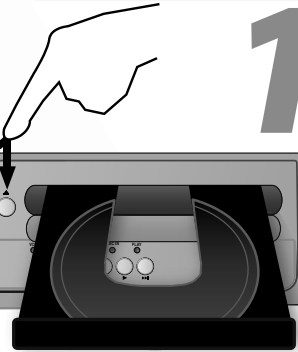

- 2** Insert a disc with its label side facing up.
Inserte un disco con el lado de la etiqueta hacia arriba.

- Depending on the disc, playback will start automatically without pressing .
- In case the DVD is recorded on both sides, make sure the label of the side you want to playback is facing up.

- 3** Press to switch to the DVD mode.
Pulse para cambiar al modo de DVD.

REMEMBER

- You need to press first every time you operate any of DVD functions / features.

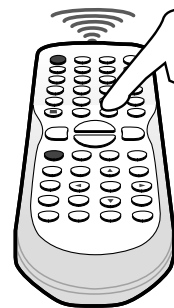

- Press to start playback.
Pulse para comenzar la reproducción.

- 4** Press to stop the playback.
Pulse para detener la reproducción.



For advanced playback, refer to the following pages.

- Disc Menu p.16
- Still Mode p.15
- Zoom p.16
- Search Functions p.16
- Programmed Playback p.18
- Resume Playback p.16
- Step-by-step Playback p.15
- Repeat Playback p.17
- Angle p.16
- Random Playback p.18

BASIC OPERATIONS

Hint for Disc Playback

The contents of DVD are generally divided into "titles". Titles may be further subdivided into "chapters". The audio CD contains "tracks".

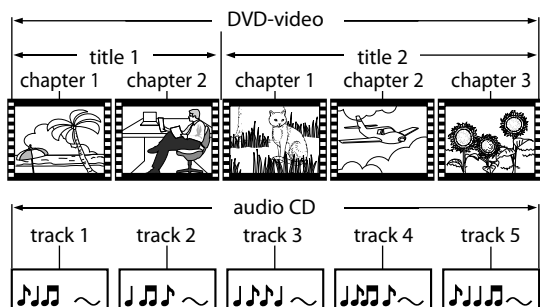

Fast Forward / Fast Reverse Playback

DVD-Video Audio CD Press first.

Press or repeatedly during playback to select the desired forward or reverse speed.

Using , on this unit

Pressing and holding or on this unit will also change forward or reverse playback speed.

Return to the normal playback, press .

VHS Press first.

Press or (or on this unit) during playback.

Return to the normal playback, press .

- Note:**
- For DVD and audio CD, fast forward or fast reverse speed is different depending on the disc. Approximate speed is 1(2x), 2(4x), 3(8x), 4(16x) and 5(32x).
 - For VCR, press again so the unit will search at higher-speed. (in the SLP mode only.)

Still Mode / Step-by-step Playback

DVD-Video Audio CD Press first.

Press **[PAUSE II]** during playback.

DVD-Video only

The picture goes forward by one frame each time you press **[PAUSE II]** in the still mode.

Return to the normal playback, press .

VHS Press first.

Press **[PAUSE II]** during playback.

The picture goes forward by one frame each time you press **[PAUSE II]** in the still mode.

- If the picture is distorted or rolling vertically, adjust the vertical hold control on your TV if equipped.

Return to the normal playback, press .

- Note:**
- For DVD, set "STILL MODE" to "FIELD" in "DISPLAY" menu if pictures in the pause mode are blurred. (→ page 23.)
 - For VCR, to prevent damage to the cassette tape, still mode will automatically stop after 5 minutes.

Slow Forward Playback

DVD-Video Press first.

Press **[PAUSE II]** during playback, then press repeatedly to select the desired forward speed.

Using on this unit

Pressing and holding on this unit in the still mode will also change forward playback speed.

Return to the normal playback, press .

VHS Press first.

Press **[PAUSE II]** during playback, then press (on this unit.)

- Press or (or on this unit) to change the speed.
- If the distorting picture appears, you can adjust it by using **[TRACKING ▲/▼]**.

Press to return to the normal playback.

- Note:**
- For DVD, slow forward speed is different depending on the disc. Approximate speed is 1(1/32x), 2(1/16x), 3(1/8x), 4(1/4x) and 5(1/2x).
 - For DVD, set "STILL MODE" to "FIELD" in "DISPLAY" menu if pictures in the slow forward are blurred. (→ page 23.)
 - For VCR, to prevent damage to the cassette tape, slow mode will automatically stop after 5 minutes.

To Skip the Titles, Chapters or Tracks

DVD-Video Audio CD Press first.

Press **[PREV I◀◀]** or **[NEXT ▶▶]** during playback to skip titles, chapters or tracks to a desired point.

Using , on this unit

Pressing or on this unit will also skip titles / chapters / tracks to a desired point.

To Reset the Cassette Tape Counter (Counter Reset)

VHS Press first.

Press **[DISPLAY]** to display the cassette tape counter on the TV screen. Then, press **[CLEAR]** to reset the counter to "0:00:00".

- Note:**
- This function is not available if the unit begins the timer recording or one-touch timer recording.

To Rewind the Cassette Tape automatically (Auto Rewind)

VHS Press first.

When a cassette tape ends during playback, fast-forward or normal recording, the unit will automatically rewind to the beginning of the cassette tape. After rewinding finishes, the unit will eject the cassette tape.

ADVANCED PLAYBACK

Disc Menu

DVD-Video Press  first.

Some discs contain menus which allow you to customize DVD playback. Use [**▲** / **▼** / **◀** / **▶**] to select an item, then press [**OK**] (or [**▶**]).

Calling Up a Menu Screen During Playback

DVD-Video Press  first.

- Press [**DISC MENU**] to call up the disc menu.
- Press [**TITLE**] to call up the title menu.

Note: • Menu operations may vary depending on the disc. Refer to the manual accompanying the disc for details.

Resume Playback

DVD-Video **AudioCD** Press  first.

- 1) Press [**■**] during playback. Resume message will appear on the TV screen.
- 2) Press [**▶**], playback will resume from the point at which playback was stopped.

Note: • To cancel resume, press [**■**] one more time in the stop mode.
• The resume playback information stays on even when the power is turned off, as long as the disc stays in the unit.



Zoom

DVD-Video Press  first.

- 1) Press [**ZOOM**] repeatedly to select the desired zoom factor: 2x, 3x, 4x, 1/2x.
- 2) Use [**▲** / **▼** / **◀** / **▶**] to slide the zoomed picture across the TV screen.
- 3) To exit zoom mode, press [**ZOOM**] repeatedly.

Note: • Zoom function does not work while the disc menu is displayed.

Camera Angles

Some DVD may contain scenes which have been shot simultaneously from the various angles. You can change the camera angle if  appears on the TV screen. If the "ANGLE ICON" is set to "OFF" in "OTHERS" menu,  will not appear. (→ page 23.)

DVD-Video Press  first.

- 1) During playback, press [**ANGLE**].
Each time you press [**ANGLE**], camera angle changes.

Stereo Sound Mode

This unit allows you to select a sound mode during CD playback.

AudioCD Press  first.

- 1) During playback, press [**AUDIO ■**].
Each time you press [**AUDIO ■**], sound mode changes as example below.

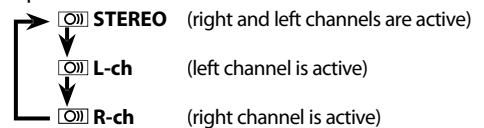

Title, Chapter, Track Search

DVD-Video **AudioCD** Press  first.

- 1) Press [**SEARCH**] for the title, chapter, track search.
For the chapter search, press [**▶**] to highlight .

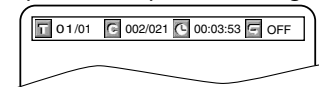

- 2) Use [**the Number buttons**] to enter the desired title, chapter or track number within 5 seconds.
- 3) Press [**OK**].
• To play back a double-digit track, press the track number directly (e.g. for track 14, press [**1**], [**4**] and [**OK**]).

Note: • Depending on the DVD being played back, this function can also be performed by directly entering the desired chapter number with [**the Number buttons**]. Refer to the manual accompanying the disc.
• For DVD and audio CD, title, chapter or track search is not available during programmed or random playback.

ADVANCED PLAYBACK

Index Search

VHS Press  first.

- 1) Press **[SEARCH]** once.
- 2) Use **[▲]** or **[▼]** to select a desired index number.
- 3) Press **[◀]** to Fast Rewinding or **[▶]** to Fast Forwarding.
- 4) When the cassette tape has reached an index mark, playback will start automatically.

Note:

- The time gap between index marks must be more than 1 minute for SP mode, 2 minutes for LP mode and 3 minutes for SLP mode.
- The index search is not available during recording.
- Press **[■]** to stop the search.
- If a cassette tape ends during a search, the index search will be cancelled and the unit will rewind to the beginning of the cassette tape.

Time Search

DVD-Video **AudioCD** Press  first.

- 1) Press **[SEARCH]**.
- 2) Press **[▶]** once to highlight  when operating audio CD. Press **[▶]** twice to highlight  when operating DVD.

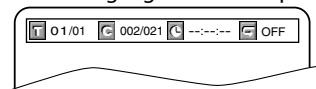

- 3) Use **[the Number buttons]** to enter the desired time within 5 seconds, then press **[OK]**. Playback will start automatically.

VHS Press  first.

- 1) Press **[SEARCH]** twice.
- 2) Use **[▲ / ▼]** to select a desired time. Then, press **[▶]** to Fast Forward, or press **[◀]** to Fast Rewind. When the cassette tape is reaches to the selected time, playback will start automatically.

Note:

- For DVD, (e.g. to play time 0:15:00) press **[1].[5].[0].[0]** of **[the Number buttons]**.
- For DVD and audio CD, press **[CLEAR]** to erase the incorrect input at step 3.
- For VCR, press **[■]** to stop the search.
- For VCR, if a cassette tape ends during a search, the time search will be cancelled and the unit will rewind to the beginning of the cassette tape.
- The time search is not available for programmed and random playback of a DVD or an audio CD or during recording of the VCR.

Repeat Playback

Repeat function is available only during playback.

DVD-Video **AudioCD** Press  first.

- 1) During playback, press **[REPEAT]**.
 - Each time you press **[REPEAT]**, repeat function changes as below.

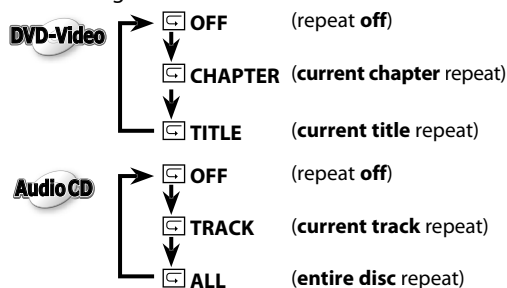

Note:

- Repeat playback is not available with some discs or during repeat A-B playback.

Repeat A-B Playback

DVD-Video **AudioCD** Press  first.

- 1) During playback, press **[A-B]** at your desired starting point as point A.
- 2) Press **[A-B]** at your desired ending point as point B.
- 3) Press **[A-B]** to exit the sequence so that "OFF" appears.

Note:

- Point B should be in the same title or track as point A.
- To cancel point A, press **[CLEAR]** at step 1.
- Repeat A-B playback is not available with some discs or during repeat playback.

Auto Repeat Playback

The unit will automatically rewind the cassette tape when it has reached the end and will automatically start playback unless you press **[■]** or you turn off the unit.

VHS Press  first.

- 1) In stop mode, press **[SETUP]**.
- 2) Use **[▲]** or **[▼]** to select "AUTO REPEAT".
- 3) Press **[▶]** to "AUTO REPEAT" to set "ON" or "OFF".
- 4) Press **[SETUP]** to exit.

Note:

- The auto repeat can also be set to "ON" or "OFF" by pressing **[REPEAT]** on the remote control.
- To cancel auto repeat, follow step 1 above. Then, press **[▶]** so that "OFF" appears beside "AUTO REPEAT". Press **[SETUP]** to exit.
- The auto repeat playback will start automatically if you select "AUTO REPEAT" to "ON" in the stop mode.

ADVANCED PLAYBACK

Programmed Playback

You can change the playback order of chapters / tracks.

DVD-Video **AudioCD** Press  **first.**

- 1) During Playback, press **[MODE]** twice when operating audio CD.
During Playback, press **[MODE]** three times when operating DVD.

- 2) Use **[◀]** or **[▶]** to select "PROGRAM". Then press **[OK]**.

For DVD:

- 3) Use **[▲/▼/◀/▶]** to select desired title (DVD) input field.



- 4) Use **[the Number buttons]** to enter desired title (DVD) number.



- 5) Press **[OK]**, then use **[the Number buttons]** to enter desired chapter number (DVD).



- 6) Repeat steps 3 to 5 to enter another title and chapter (DVD) numbers.
- 7) Use **[▲/▼/◀/▶]** to select "PLAY", then press **[OK]**.

For audio CD:

- 3) Use **[▲/▼/◀/▶]** to select desired track input field.
- 4) Use **[the Number buttons]** to enter desired track number.

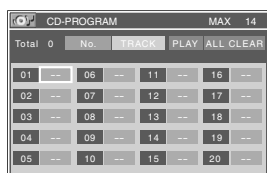

- 5) Repeat steps 3 to 4 to enter another track number.

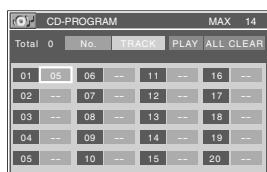

- 6) Use **[▲/▼/◀/▶]** to select "PLAY", then press **[OK]**.

- Note:**
- Up to 20 chapters or tracks can be ordered.
 - To erase all the programs at once, select "ALL CLEAR" and press **[OK]** or press **[CLEAR]** in program input.
 - The number of the title or chapter you enter using **[the Number buttons]** cannot exceed the maximum number of the chapters or tracks on the disc.
 - During the program playback, press **[■]** once to set the resume point, and then press **[▶]** to resume the program playback from the beginning of the track where the **[■]** was pressed.
 - During the program playback, press **[■]** twice to cancel the program playback. Your programs are still stored until either the disc is removed or power is turned off.
 - Some DVD will not allow you to set programmed playback.
 - During programmed playback, "TITLE" repeat (DVD) is not available.

Random Playback

This function shuffles the playing order of chapters/tracks instead of playing back in sequence.

DVD-Video **AudioCD** Press  **first.**

- 1) During playback, press **[MODE]** twice when operating audio CD.
During playback, press **[MODE]** three times when operating DVD.
- 2) Use **[◀]** or **[▶]** to select "RANDOM". Then press **[OK]**.

- Note:**
- During random playback, you cannot go back to the previous track. Pressing **[NEXT ▶▶]** allows you to search chapters or tracks randomly.
 - During DVD random playback, you can play back chapters in the current title randomly.
 - Some DVD will not allow you to set random playback.

Settings

Black Level Setting

Adjust the black level to make the dark areas of the picture brighter.

DVD-Video Press  **first.**

- 1) During playback, press **[MODE]** once.
- 2) Use **[◀]** or **[▶]** to adjust the black level.
ON: makes the dark areas brighter.
OFF: shows the original picture as recorded.
- 3) Press **[RETURN ↵]** to exit.

Subtitle Language and Audio Language

This unit allows you to select a subtitle (if available) or an audio language (if multiple languages are available for audio language) during DVD playback.

DVD-Video Press first.

To Change the Subtitle Language

- 1) During Playback, press **[SUBTITLE]**.
Each time you press **[SUBTITLE]** during Playback, the subtitle language changes as example below.

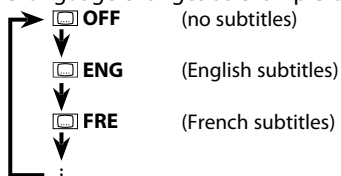

- 2) To cancel the subtitle, use **[▶]** or **[◀]** to set subtitle to "OFF".

To Change the Audio Language

- 1) During Playback, press **[AUDIO ▢]**.
Each time you press **[AUDIO ▢]** during Playback, the audio language changes as example below.



Note:

- If your language is not shown after pressing **[SUBTITLE]** or **[AUDIO ▢]** several times, the disc may not have that language. However, some discs allow subtitle/audio language setting on the disc menu.
- When "Ⓞ" appears on the TV screen, it means no subtitle/audio are recorded on the scene.
- Some discs will only allow you to change the subtitle/audio language setting from the disc menu.
- Operation varies depending on the disc, so refer to the manual along with the disc for details.

On-Screen Display

You can refer to the various information on the screen when you press **[DISPLAY]**.

Press first.

DVD-Video

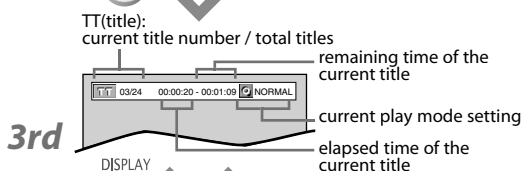
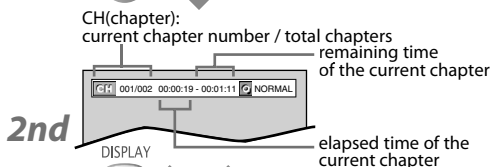
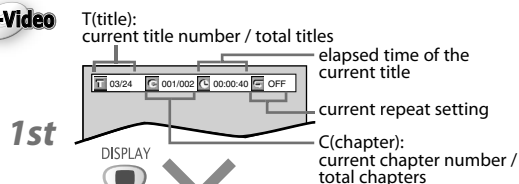

Normal display (display off)

Audio CD

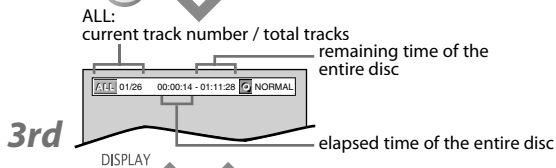
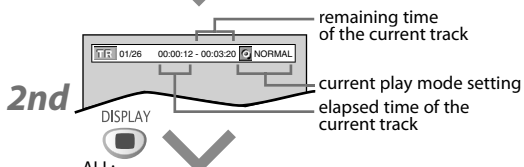
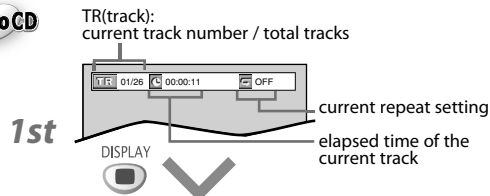

Normal display (display off)

RECORDING

BASIC RECORDING

Before: Turn on the TV.

This unit has no tuner system so it cannot receive TV broadcasts without external tuner or such devices.

- Note:**
- You can also set the external tuner for timer recording. Refer to "Satellite Link" on page 22.
 - You **CANNOT** dub a DVD to a video cassette tape.
 - Do not change the external tuner's channel while you are recording. You **CANNOT** watch one channel and record another at the same time.

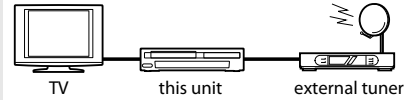

Recording & OTR (One-touch Timer Recording)

1 Press to turn on the unit. Then insert a recordable tape.

Para encender la unidad, pulse . Luego inserte una cinta grabable.

- If the erase-protection tab has been removed, cover the hole with clear tape. See * below.

2 Press to switch to the VCR mode.

Para cambiar al modo de VCR, pulse .

REMEMBER

- You need to press first every time you operate any of VCR features.

3 Press until "L1" or "L2" is displayed on the TV screen. Select "L1" to activate rear input jacks. Select "L2" to activate front input jacks.

Pulse hasta que se visualice "L1" o "L2" en la pantalla de la TV. Seleccione "L1" para activar los conectores posteriores de entrada. Seleccione "L2" para activar los conectores frontales de entrada.

4 Press to select the desired tape speed.

Pulse para seleccionar la velocidad deseada de la cinta.

Tape speed	Recording / playback time		
Type of tape	T60	T120	T160
SP mode	1hour	2hours	2-2/3hours
SLP mode	3hours	6hours	8hours

• LP mode cannot be Recorded, LP mode can be Played back.

Press until desired duration recording time is selected.

Pulse hasta que se seleccione el tiempo de duración de grabación deseado.

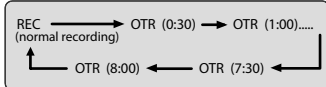

6 To stop recording temporarily, press .

Para detener la grabación temporalmente, pulse .

- During the recording in the pause mode, 5 marks appear on the TV screen. Each mark represents 1 minute.
- Press again to resume recording.
- Pause mode will be automatically cancelled after 5 minutes to prevent damage to the cassette tape and the video head.

7 Press to stop recording.

Pulse para detener la grabación.

8 Press to eject the recorded cassette tape.

Pulse para expulsar el casete grabado.

*** Accidental Erasure Prevention**

To prevent accidental recording, remove erase-protection tab of the cassette tape. To record again, cover the hole with adhesive tape.



How to set the timer recording or satellite link, refer to pages 21-22.

Timer Recording

VHS Press **VCR** first.

- 1 Press **SETUP**, use **▲** / **▼** to select "TIMER PROGRAMMING". Then, press **▶** to go to next step.

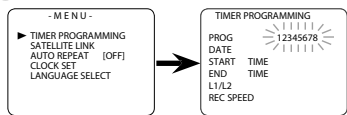

Available program number blinks.

- 2 Use **▲** / **▼** to select an empty program number. Then, press **▶** to go to next step.

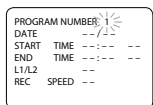

- 3 Use **▲** / **▼** to select "ONCE", "DAILY" (Mon-Fri), or "WEEKLY". Then, press **▶** to go to next step.

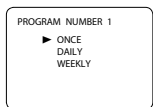

- 4 Use **▲** / **▼** to select the desired month. Then, press **▶** to go to the next step.

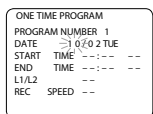

Then, repeat procedures above to select the day, start time, end time, and "L1" or "L2" as well.

- 5 Use **▲** / **▼** to select recording speed. Then, press **CLEAR** to remove the MENU.

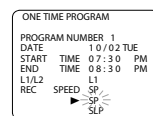

To set another program after step 5, press **▶**. Then, repeat procedures from steps 2 through 5. You can program the unit to record up to 8 programs, and up to 1 year in advance.

- 6 Press **TIMER SET** to set the timer standby mode.

The **[TIMER REC]** indicator on this unit lights up and the unit goes to the DVD mode.

Note:

- To go back one step, press **[◀]** during steps 3 to 5.
- Select "L1" or "L2" to activate rear input jacks or front input jacks accordingly.

To Check, Correct or Cancel a Timer Program

- 1) Press **[TIMER SET]**, and then press **[VCR ∞]** on the remote control.
- 2) Repeat procedures in step 1 above.
- 3) Use **[▲ / ▼]** to select the program number you want to check. The details of the program you select will appear on the TV screen. Use **[◀ / ▶]** to go to the digit you want to change. Then, use **[▲ / ▼]** to enter the correct numbers. You can cancel the entire program by pressing **[◀]** while the program number blinks.
- 4) Press **[CLEAR]** to exit.
- 5) Press **[TIMER SET]** to return to the timer standby mode.

To Cancel a Timer Recording in Progress

Press **[■ ▲]** on the unit.

Note for Timer Recording & OTR

- If a power failure occurs or the cassette tape does not have the erase-protection tab, the **[TIMER REC]** indicator blinks and timer recording cannot be performed.
- If there is a power failure occurred or the unit is unplugged for more than 30 seconds, clock setting and all programmed timer recordings will be lost.
- If a cassette tape runs out before an OTR or a timer recording is finished, the unit ejects the cassette tape.

After an OTR or a Timer Recording Has Been Set, This Unit Operates as Follows:

- Press **[TIMER SET]** on the remote control or **[■ ▲]** on the unit, then press **[VCR ∞]** to activate the VCR function again.
- To cancel the timer standby mode, press **[TIMER SET]** on the remote control or **[■ ▲]** on the unit, then press **[VCR ∞]** to activate the VCR function again.

When an OTR or a Timer Recording is Completed.

- If timer programmings are left on the VCR, the unit will switch to the DVD mode and then the VCR will go standby for the next timer recording. (All the VCR functions will be unavailable.) If auto power off has been in effect, however, both DVD and VCR will go to standby mode.
- All the DVD functions are available while the VCR is in OTR, Timer standby, or Timer Recording mode.
- The **[TIMER REC]** indicator blinks if there are no more timer programs.
- Press **[■ ▲]** on this unit or **[TIMER SET]** on the remote control to use the VCR when the unit is turned off.

To Use the DVD Player During Timer Recording or While the [TIMER REC] Indicator is On or Blinking.

- Press **[⊙]** to turn On the unit. Press **[DVD ⊙]** on the Remote Control to choose DVD mode. Then continue with the other DVD features as described in this manual.

Satellite Link

You can set the unit to start recording whenever it detects a video signal from the external tuner.

Preparing for the Satellite Link:

- Only L1 (rear) is available for satellite link and be sure that this L1 needs to be connected by the external tuner.
- The external tuner should be equipped with some kind of timer function. Using timer function of the tuner, set it to the output audio/video signals when it comes to the time you want to start recording, and stop those signals when it comes to the time you want to finish recording. Refer to the tuner's manual on how to set the timer.

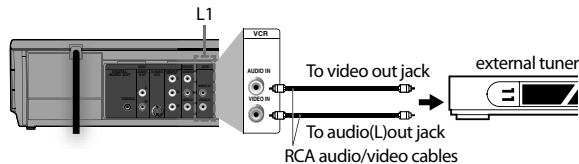

VHS Press **VCR** first.

1 Press **SPEED** to select the desired tape speed.

SP

2 In the stop mode, press **SETUP**.

3 Use **▲** / **▼** to select "SATELLITE LINK". Then, press **▶** to go to the next step.

- M E N U -
 TIMER PROGRAMMING
 ▶ SATELLITE LINK
 AUTO REPEAT [OFF]
 CLOCK SET
 LANGUAGE SELECT

4 Use **▲** / **▼** to select the desired hour. Then, press **▶** to go to the next step.

SATELLITE LINK
 01 : 30 PM

Then, repeat procedures above to select the minute as well.

The hour can be selected from 1-12 with AM or PM.

When the external tuner signal is stopped, recording will be stopped.

5 Press **▶** to set satellite link standby mode.

SATELLITE LINK
 01 : 30 PM
 [ON]

[TIMER REC] indicator: lights up and the unit goes to the DVD mode. If you do not use DVD function, turn OFF the unit.

An external tuner must be turned ON for satellite link to start. If external tuner is not set to output signals, satellite link will remain in standby mode.

To Cancel the Satellite Link on Standby:

Press **[TIMER SET]** on the remote control or **■ ▲** on this unit.

To Cancel the Satellite Link in Progress:

Press **■ ▲** on this unit.

- Note:**
- Recording picture will be distorted if the copy protection signal is being detected during satellite link.
 - When the timer recording and the satellite link are overlapped, those recordings are recorded as illustrated below.

e.g.) In case of the satellite link is overlapped on the existing timer recording.

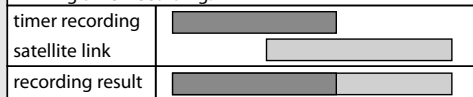

e.g.) In case of the timer recording is programmed in the middle of the satellite link.



e.g.) In case of the timer recording is overlapped on the existing satellite link.

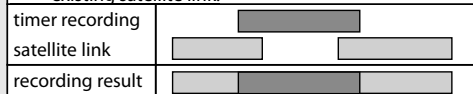

Dubbing a Cassette Tape

Warning: Unauthorized recordings of copyrighted cassette tapes may be an infringement of copyright laws.

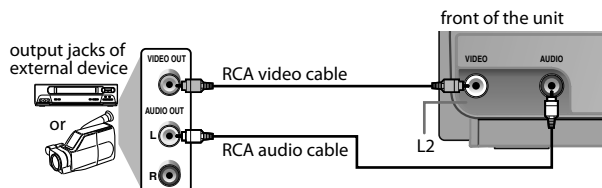

You can use a video disc player, cable/satellite box or other devices with Audio/Video output jacks.

VHS Press **VCR** first.

- 1) Press **[SPEED]** on the remote control to select recording speed (SP or SLP).
- 2) Press **[INPUT SELECT]** on the remote control to select L1 or L2 whichever Jack the external device is connected to.
- 3) Press **[REC]** on the unit, and then start playback of the external device.
- 4) To stop recording, press **■ ▲** on this unit.
- 5) Stop playback of the external device.

Note: • For best results during dubbing, use buttons on this unit whenever possible. The remote control might affect another device's operation.

OPTIONAL SETTINGS

Changing the DVD Settings (in the setup menu)

In the setup menu, you can customize the various kinds of settings as you prefer. Refer to the following instructions to navigate through the setup menus.

- 1) Press **[SETUP]**.
- 2) Use **[◀/▶]** to select a setup item.
- 3) Use **[▲/▼]** to go up or down in the menu list.
- 4) Press **[OK]** to access the sub contents of the highlighted item.
- 5) Use **[▲/▼]** to select a setting.
- 6) Press **[SETUP]** to exit.

- The following table is the contents which you can set and the default settings. Refer to the table for useful operation.
- Your change to each setting stays activated even when the unit is turned off.

Setup menu (highlight is the default)		Contents	Notes
LANGUAGE	AUDIO	ORIGINAL ENGLISH FRENCH SPANISH ⋮ OTHER	Set the language for audio.
	SUBTITLE	OFF ENGLISH FRENCH SPANISH ⋮ OTHER	Set the language for subtitles.
	DISC MENU	ENGLISH FRENCH SPANISH ⋮ OTHER	Set the language for disc menu language.
	PLAYER MENU	ENGLISH FRANÇAIS ESPAÑOL	Set the language for OSD (on-screen display).
DISPLAY	TV ASPECT	4:3 LETTER BOX 4:3 PAN & SCAN 16:9 WIDE	Set the picture size according to aspect ratio of your TV.
	STILL MODE	AUTO FIELD FRAME	Set the type of still image in pausing playback. Select "AUTO" usually.
AUDIO	DRC (Dynamic Range Control)	ON OFF	Set to "ON" to compress the range between soft and loud sounds.
	DOWN SAMPLING	ON OFF	Set to "ON" when outputting in 48kHz. Set to "OFF" when outputting the original sound.
	DOLBY DIGITAL	BITSTREAM PCM	Set the type of sound signal which outputs from the digital audio output jack.
PARENTAL	PASSWORD	NO YES	Enter the password.
	LEVEL	LEVEL8 [ADULT] LEVEL7 [NC-17] to LEVEL1 [KID SAFE]	Set the parental level for DVD playback. (Refer to page 24.)
	CHANGE		Set and change the password. (Refer to page 24.)
OTHERS	ANGLE ICON	ON OFF	Set whether to display the angle icon or not.

OPTIONAL SETTINGS

Press  first.

Press  if you are playing back a disc.



PARENTAL Setting

Parental setting will prevent your children from viewing inappropriate materials (password protected). Playback will stop if the ratings exceed the levels you set.

To Set the Parental Level

1 Press  to call up the setup menu.

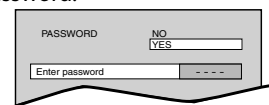

2 Use  /  to select .

3 Press , and then use  /  to select "YES".
When you use the unit for the first time, use **[the Number buttons]** to enter the 4-digit number for your password (except for 4737). Then, re-enter the new password.



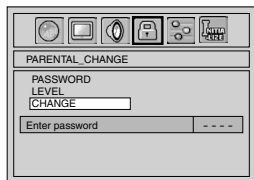

- If you have set password already, use **[the Number buttons]** to enter the current 4-digit password.

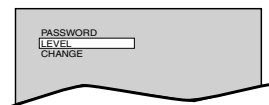

4 Use  /  to select "LEVEL", then press .



5 Use  /  to select the desired level, then press .

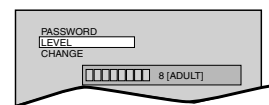

6 Press  to exit.

CONTROL LEVELS

- Level 8: DVD software of any grades (adult/general/children) can be played back.
- Levels 7 to 2: only DVD software intended for general use and for children.
- Level 1: only DVD software intended for children, with those intended for adult and general use prohibited.

TIPS FOR LEVELS



- 8 [ADULT]: DVD software of any grades (adult/general/children) can be played back.
- 7 [NC-17]: no one under 17 admitted
- 6 [R]: restricted; under 17 requires accompanying parent or adult guardian
- 5 [PGR]: parental guidance recommended
- 4 [PG13]: unsuitable for children under 13
- 3 [PG]: parental guidance suggested
- 2 [G]: general audience
- 1 [KID SAFE]: suitable for children

Note:

- Record the password in case you forget it.
- Some DVD-video may not respond to "PARENTAL" setting. Make sure this function works with your DVD-video.
- The resume information will be cleared if you change the parental level when the resume information is on.

To Change the Password

1 Follow the step 1 to 3 in "To Set the Parental Level" on the left.

2 Use  /  to select "CHANGE", then press .

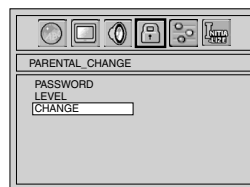

3 Use **[the Number buttons]** to enter the new 4-digit password (expect for 4737). Then, re-enter the new password.

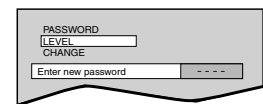

4 Press  to exit.

Note:





- If you forget the password, press [4], [7], [3], [7], then enter your new password. Password will be cleared and parental levels will be set to "LEVEL 8 [ADULT]".



OPTIONAL SETTINGS

INITIALIZE



Reset the settings to factory default.

1 Press  to call up the setup menu.

2 Use  /  to select , then press .

3 Press  to select "YES"; then press .



4 Press ,  or  to select the desired language.

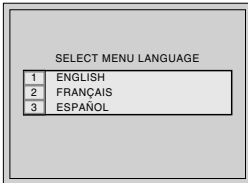

The next time you operate, the player menu language will be the one you have selected.

TROUBLESHOOTING

Troubleshooting Guide

If this unit does not perform properly when operated as instructed in this manual. Refer to the following:

	Symptom	Remedy
DVD • VCR	No power.	<ul style="list-style-type: none"> • Make sure the power plug is connected to an AC outlet. • Make sure the power is turned on.
	This unit does not respond to the remote control.	<ul style="list-style-type: none"> • Check if the power plug is connected to an AC outlet. • You have to be within 23 feet (7m) of this unit. • Check if a cassette tape or disc is in this unit. • Make sure nothing is blocking the unit's IR receiver window. • Inspect and/or replace the batteries in the remote control. • Check if the Remote Control is sending out an IR signal, refer to page 27.
	Poor picture or noise.	<ul style="list-style-type: none"> • Interference signal may be received. Change the position and direction of the unit.
	Cannot remove the cassette tape or disc.	<ul style="list-style-type: none"> • Check if this unit is in the DVD or VCR mode. If not, press [DVD] or [VCR] on the remote control to switch the mode. • Turn Power Off. Turn Power back On and immediately press the DVD or VCR Eject Button repeatedly to Eject the Disc or Cassette .
VCR	Cannot record a TV program.	<ul style="list-style-type: none"> • This unit does not have a tuner to receive TV broadcasting. • You must connect this unit to TV with audio/video output jacks or an external tuner to record TV programs. Refer to "Recording & OTR (One -touch Timer Recording)" on page 20 and "Satellite Link" on page 22.
	Timer recording is impossible.	<ul style="list-style-type: none"> • Make sure the timer program is set correctly. • Make sure [TIMER REC] indicator on this unit lights up. If not, press [TIMER SET]. • Make sure the VCR clock is set correctly.
	Cannot go into record mode.	<ul style="list-style-type: none"> • Make sure the cassette tape has a record tab. If needed, cover the hole with tape. • Activate this unit in VCR mode. Press [VCR ∞] on the remote control so that the [VCR] indicator will illuminate.
	Playback picture is partially noisy.	<ul style="list-style-type: none"> • Adjust tracking control for a better picture by pressing [TRACKING ▲ / ▼].
	Cannot view a picture but the audio is OK.	<ul style="list-style-type: none"> • Head cleaning may be necessary. Refer to "Auto Head Cleaning" (page 27).
	No or poor, playback picture.	<ul style="list-style-type: none"> • Adjust tracking control for a better picture by pressing [TRACKING ▲ / ▼]. • Connect the video cable firmly.
	Video or color fades in and out when making a copy of a cassette tape.	<ul style="list-style-type: none"> • You cannot copy a copyrighted cassette tape.
No picture and sound.	<ul style="list-style-type: none"> • Please confirm to connect to DVD/VCR AUDIO OUT and DVD/VCR VIDEO OUT. 	
DVD	No picture.	<ul style="list-style-type: none"> • Connect the video cable firmly. • Insert a correct video disc that can be played back on this unit. • Press [DVD ⊙] on the remote control. Check if the [DVD] indicator will illuminate. Then try other DVD features.
	Disc cannot be played back.	<ul style="list-style-type: none"> • Insert the disc. • Clean the disc. • Place the disc correctly with the label side up. • Cancel the parental lock or change the control levels. • Handle a disc with special care so that it does not have fingerprints, scratches, or dusts on its surface.
	No sound.	<ul style="list-style-type: none"> • Connect the audio cables firmly. • Turn on the power of the audio component. • Correct the audio output settings. • Correct the input settings on the audio component. • Turn up Sound on TV or remove Mute function from the TV.
	No DTS audio is output.	<ul style="list-style-type: none"> • This unit does not support DTS audio.
	Distorted picture.	<ul style="list-style-type: none"> • Connect this unit directly to the TV. • There are some cases where pictures may be slightly distorted, and those are not a sign of a malfunction. • Although pictures may stop for a moment, this is not a malfunction.
	Audio or subtitle language does not match the setting.	<ul style="list-style-type: none"> • The selected language is not available for audio or subtitles on the DVD.
	The camera angle cannot be changed.	<ul style="list-style-type: none"> • The DVD does not always contain sequences recorded from different camera angles.
	Audio or subtitle language cannot be changed.	<ul style="list-style-type: none"> • The DVD does not always contain audio source or subtitles in the selected language. • The DVD Audio or subtitle language may only be changed using the disc Menu.
	"⊙" appears on the TV screen, prohibiting an operation.	<ul style="list-style-type: none"> • The operation is prohibited by this unit or the disc.

- Some functions are not available in specific modes, but this is not a malfunction. Read the description in this manual for details on correct operations.
- Playback from a desired track and random playback are not available during programmed playback.
- Some functions are prohibited on some discs.

Maintenance

Servicing

- Please refer to relevant topics on the “Troubleshooting Guide” on page 26 before returning the product.
- If this unit becomes inoperative, do not try to correct the problem by yourself. There are no user-serviceable parts inside. Turn off, unplug the power plug, and please call our toll free customer support line found on the cover of this manual to locate an authorized service center.

Cleaning the Cabinet

- Wipe the front panel and other exterior surfaces of the unit with a soft cloth.
- Never use a solvent, thinner, benzene or alcohol to clean the unit. Do not spray insecticide liquid near the unit. Such chemicals may discolor the surface or damage the unit.

Cleaning Discs

- When a disc becomes dirty, clean it with a cleaning cloth. Wipe the disc from the center to out. Do not wipe in a circular motion.
- Do not use solvents such as benzene, thinner, commercially available cleaners, detergent, abrasive cleaning agents or antistatic spray intended for analog records.

Cleaning the Disc Lens

- If this unit continues to perform improperly even after you have referred to the relevant sections and to the “Troubleshooting Guide” in this manual, the laser optical pickup unit may be dirty. Consult your dealer or an authorized service center for inspection and cleaning of the laser optical pickup unit.

Disc Handling

- When you handle a disc, hold it by its edge and try not to touch the surface of the disc.
- Always store the disc in its protective case when not in use.
- Do not glue paper or put stickers onto the disc. This may damage the disc, and the unit may not read it correctly.

Specifications

Output signal format:	NTSC color
Video heads:	Rotary four-head
Tape width:	1/2 inch (12.65 mm)
Tape speeds:	SP: 1-5/16 inch/sec. (33.40 mm/sec) LP: 16.67 mm/sec. SLP: 7/16 inch/sec. (11.12 mm/sec.)
Disc media size:	5 inches (12 cm) / 3 inches (8 cm)
Terminals:	
Component video output:	RCA jack x 3 Y: 1 Vp-p (75 Ω) Pb: 700 mVp-p (75 Ω) Pr: 700 mVp-p (75 Ω)
S-video output:	Mini DIN 4-pin jack x 1 Y: 1 Vp-p (75 Ω) C: 286 mVp-p (75 Ω)
Video output:	RCA jack x 1 1 Vp-p (75 Ω)
Coaxial digital audio output:	RCA jack x 1 500 mVp-p (75 Ω)
Audio output:	RCA jack x 4 2 V rms
Video input:	RCA jack x 2 1 Vp-p (75 Ω)
Audio input:	RCA jack x 2 2 V rms

Auto Head Cleaning

- Automatically cleans video heads as you insert or remove a cassette tape, so you can see a clear picture.
- If the playback picture is blurred or interrupted while the TV broadcast is showing clear, the dirt may have accumulated on the video heads, or the usage of rental or worn cassette tapes can cause this problem. If a streaky or snowy picture appears during playback, the video heads in your unit may need to be cleaned.
 1. Please visit your local audio/video store and purchase a good quality VHS video head cleaner.
 2. If a Video head cleaner does not solve the problem, please call our toll free customer support line found on the cover of this manual to locate an authorized service center.

Note:

- Remember to read the instructions along with the video head cleaner before use.
- Clean video heads only when problems occur.

IR Signal Check

- If the remote control does not work properly, you can test if the remote control is sending out the infrared signal with a digital camera (including built-in camera of cellular phone). It will help to define the cause of malfunction.

With a digital camera

(including built-in camera of cellular phone):

Direct a digital camera to remote control, press and hold a button on remote control. If infrared light appears through digital camera, the remote control is working.



Remote control:	Digital encoded infrared light system
Operating temperature:	41°F (5°C) to 104°F (40°C)
Power requirements:	120 V AC +/- 10%, 60 Hz +/- 0.5%
Power consumption (maximum):	16 W (standby: 2.8 W)
Dimensions:	W: 17 3/16" (435 mm) H: 3 3/4" (94 mm) D: 9 3/16" (233 mm)
Weight:	Approx. 5.63 lbs (2.55 kg)

- Designs and specifications are subject to change without notice.
- If there is a discrepancy between languages, the default language will be English.

LIMITED WARRANTY

NINETY (90) DAY LABOR / ONE (1) YEAR PARTS

WARRANTY COVERAGE:

This warranty obligation is limited to the terms as set forth below.

WHO IS COVERED:

This product warranty is issued to the original purchaser or the person receiving the product as a gift against defects in materials and workmanship as based on the date of original purchase ("Warranty Period") from an Authorized Dealer. The original sales receipt showing the product name and the purchase date from an authorized retailer is considered such proof.

WHAT IS COVERED:

This warranty covers new products if a defect in material or workmanship occurs and a valid claim is received within the Warranty Period. At its option, the company will either (1) repair the product at no charge, using new or refurbished replacement parts, or (2) exchange the product with a product that is new or which has been manufactured from new, or serviceable used parts and is at least functionally equivalent or most comparable to the original product in current inventory, or (3) refund the original purchase price of the product. Replacement products or parts provided under this warranty are covered against defects in materials and workmanship from the date of the replacement or repair for ninety (90) days or for the remaining portion of the original product's warranty, whichever provides longer coverage for you. When a product or part is exchanged, any replacement item becomes your property and the replaced item becomes company property. When a refund is given, your product becomes company property. Note: Any product sold and identified as refurbished or renewed carries a ninety (90) day limited warranty.

Replacement product can only be sent if all warranty requirements are met. Failure to follow all requirements can result in delay.

WHAT IS NOT COVERED - EXCLUSIONS AND LIMITATIONS:

This Limited Warranty applies only to new company manufactured products that can be identified by the trademark, trade name, or logo affixed to it. This Limited Warranty does not apply to any hardware product or any software, even if packaged or sold with the product, as manufacturers, suppliers, or publishers may provide a separate warranty for their own products packaged with the bundled product.

The company is not liable for any damage to or loss of any programs, data, or other information stored on any media contained within the product, or other additional product or part not covered by this warranty. Recovery or reinstallation of programs, data or other information is not covered under this Limited Warranty.

This warranty does not apply (a) to damage caused by accident, abuse, misuse, neglect, misapplication, or non-supplied product, (b) to damage caused by service performed by anyone other than company approved Authorized Service Location, (c) to a product

or a part that has been modified without written company permission, or (d) if any serial number has been removed or defaced, or (e) product, accessories or consumables sold "AS IS" without warranty of any kind by including refurbished product sold "AS IS" by some retailers.

This Limited Warranty does not cover:

- Shipping charges to return defective product.
- Labor charges for installation or setup of the product, adjustment of customer controls on the product, and installation or repair of antenna/signal source systems outside of the product.
- Product repair and/or part replacement because of improper installation or maintenance, connections to improper voltage supply, power line surge, lightning damage, retained images or screen markings resulting from viewing fixed stationary content for extended periods, product cosmetic appearance items due to normal wear and tear, unauthorized repair or other cause not within the control of the company.
- Damage or claims for products not being available for use, or for lost data or lost software.
- Damage from mishandled shipments or transit accidents when returning product.
- A product that requires modification or adaptation to enable it to operate in any country other than the country for which it was designed, manufactured, approved and/or authorized, or repair of products damaged by these modifications.
- A product used for commercial or institutional purposes (including but not limited to rental purposes).
- Product lost in shipment and no signature verification receipt can be provided.
- Failure to operate per Owner's Manual.

TO OBTAIN ASSISTANCE...

Contact the Customer Care Center at:
1 877 393 8624

REPAIR OR REPLACEMENT AS PROVIDED UNDER THIS WARRANTY IS THE EXCLUSIVE REMEDY FOR THE CONSUMER, WITH THE ISSUING COMPANY NOT LIABLE FOR ANY INCIDENTAL OR CONSEQUENTIAL DAMAGES FOR BREACH OF ANY EXPRESS OR IMPLIED WARRANTY ON THIS PRODUCT. EXCEPT TO THE EXTENT PROHIBITED BY APPLICABLE LAW, ANY IMPLIED WARRANTY OF MERCHANTABILITY OR FITNESS FOR A PARTICULAR PURPOSE ON THIS PRODUCT IS LIMITED IN DURATION TO THE DURATION OF THIS WARRANTY.

Some states do not allow the exclusions or limitation of incidental or consequential damages, or allow limitations on how long an implied warranty lasts, so the above limitations or exclusions may not apply to you.

This warranty gives you specific legal rights. You may have other rights which vary from state/province to state/province.

FUNAI CORPORATION, Inc. 1990 Van Ness Avenue, Torrance, CA 90501

